

Description: **ROBINHOOD UPRIGHT FRIDGE 242L WHITE**

Model Numbers: **RHUFD242W**



Model Pictured: RHUFD242W

*Actual unit may vary from above model picture

Contents

Congratulations!

Thank you for choosing one of our appliances. Before you use the appliance, we strongly recommend that you read through the whole user manual which provides important safety instructions and description of the product and the proper use of its functions.

To avoid the ever-present risks involved with using an electrical appliance it is vital that the appliance is installed correctly and that you read the safety instructions carefully to avoid misuse and hazards. It is important that you retain these instructions and your proof of purchase along with any other important documents about this product for future reference.

Due to continual product development, Robinhood reserves the right to alter specifications or appearances without notice.

Important Safety Instructions.....	1
Installation Instructions.....	2
Appliance Details.....	5
Operating Instructions.....	6
Care and Maintenance.....	7
Troubleshooting.....	8
Data Label and Circuit Diagram.....	9
Warranty Certificate (New Zealand).....	10

Disposal Information

- Most of the packing materials are recyclable. Please dispose of these materials through your local recycling depot or by placing them in appropriate collection containers.
- If you wish to discard this product, please contact your local authorities and ask for the correct method of disposal.

Important Safety Instructions

Read the assembly instruction section and safety precautions of this booklet carefully before removing the contents of this carton.

1. This appliance is not intended for use by persons (including children) with reduced physical, sensory or mental capabilities, or lack of experience or knowledge, unless they have been given supervision or instruction concerning the use of the appliance by a person responsible for their safety. Young children should be supervised to ensure that they do not play with the appliance.
2. In certain circumstances electrical appliances may be a safety hazard.
3. Do not place heavy objects on this appliance.
4. The appliance is not intended to be operated by means of an external timer or separate remote-control system.
5. Electrical connection must be made as per local wiring rules and regulations. Do not disconnect the appliance with wet hands and do not disconnect the power cord with extreme force. Do not coil the cord while in use but keep any excess cord to the back of the appliance. Take care that the power socket is accessible.
6. The appliance should be unplugged when not in use and before any maintenance is carried out on the appliance.
7. If the supply cord is damaged, it must be replaced by the manufacturer, its Authorized Service Centre or a similarly qualified person in order to avoid a hazard.
8. Warning: Ensure that the ventilation openings, in the appliance enclosure or in the built-in structure, are not obstructed. Follow the installation requirements in this manual. Avoid prolonged exposure to direct sunlight.
9. Warning: Do not use mechanical devices or other means to accelerate the defrosting process, other than those recommended by the manufacturer.
10. Warning: Do not damage the refrigerant circuit.
11. Warning: Do not use electrical appliances inside the food storage compartments of the appliance.
12. Do not store explosive substances such as aerosol cans with flammable propellant in this appliance. Do not modify this appliance.
13. This appliance must be correctly installed by a suitably qualified person, strictly in accordance with the manufacturer's instructions. Please see the specific section of this booklet that refers to installation.
14. When disposing of this appliance, please do so according to local regulations as it contains flammable gas & refrigerant.
15. Do not place hot items on plastic areas of appliance. Do not refreeze food once defrosted. Store pre-packed frozen food in accordance with the manufacturer's instructions. Take care when freezing liquids as sealed containers can explode under pressure.



DO NOT OPERATE THIS APPLIANCE BEFORE READING THE INSTRUCTION BOOKLET
DO NOT BOOKLET PLACE ARTICLES ON OR AGAINST THIS APPLIANCE
DO NOT STORE CHEMICALS OR FLAMMABLE MATERIALS OR SPRAY AEROSOLS NEAR THIS APPLIANCE

This appliance is intended to be used in household and similar applications such as:

Staff kitchen areas in shops, offices and other working environments; Farmhouses and by clients in hotels, motels and other residential type environments; Bed & breakfast type environments, Catering and similar non-retail applications.

Installation Instructions

UNPACKING THE APPLIANCE

Remove the external & internal packaging.

When unpacking the appliance please check for any damage. If damage is found, do not connect to the power source and contact the Authorized Service Provider.

Before connecting the appliance to the power source, let it stand upright for approximately 4 hours. This will reduce the possibility of a malfunction in the cooling system from handling during transportation. Remove any protective film from the outer surface.

Clean the interior surface with lukewarm water using a soft cloth.

INSTALLING THE REFRIGERATOR

This appliance is designed to be free standing only, and should not be recessed or built in.

Place your appliance on a solid, level floor that is strong enough to support the appliance when it is fully loaded. Use the adjustable feet at the bottom of the appliance to compensate for any unevenness of the floor.

Allow at least 10 cm of space around the back and sides of the appliance, which allows the proper air circulation, and at least 20cm above the unit.

Locate the appliance away from direct sunlight and sources of heat (stove, heater, radiator, etc.). Direct sunlight may affect the acrylic coating and heat sources may increase electrical consumption. Extreme cold ambient temperatures may also cause the appliance not to perform properly. Avoid locating the appliance in moist areas.

Plug the appliance into an exclusive, properly installed-grounded wall outlet. Do not under any circumstances cut or remove the third (ground) prong from the power cord. Any questions concerning power and/or grounding should be directed toward a certified electrician or an Authorized Service Centre.

After plugging the appliance into a wall outlet (220-240V 50Hz), allow the unit to cool down for 2~3 hours before placing food in the freezer and refrigeration compartments.

If moving the appliance, avoid tilting the appliance more than 45°. At no time should the appliance be turned upside down.

SPACE REQUIREMENT

- Keep enough space of door open
- Keep at least 50mm gap at two sides

LEVELLING THE UNIT

To do this, adjust the two levelling feet at front of the unit.

If the unit is not level, the doors are magnetic seal alignments will not be covered properly.

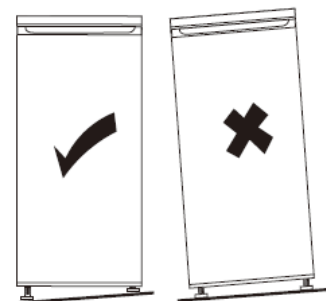

POSITIONING

Install this appliance at a location where the ambient temperature corresponds to the climate class indicated on the rating plate of the appliance:

Climate class	Ambient temperature
SN	+10°C to +32°C
N	+16°C to +32°C
ST	+16°C to +38°C
T	+16°C to +43°C

Installation Instructions

REVERSING THE DOOR POSITION

1. Remove the top right hinge cover, remove the screws and then remove the hinge bracket.

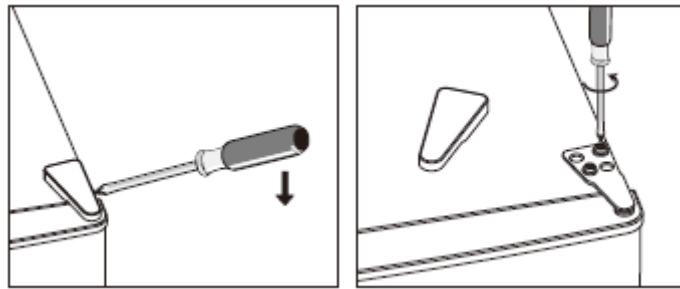

2. Remove the top left screw cover. Then move the core cover from left side to right side. After that, lift the upper door and place it on a padded surface to prevent it from scratching.

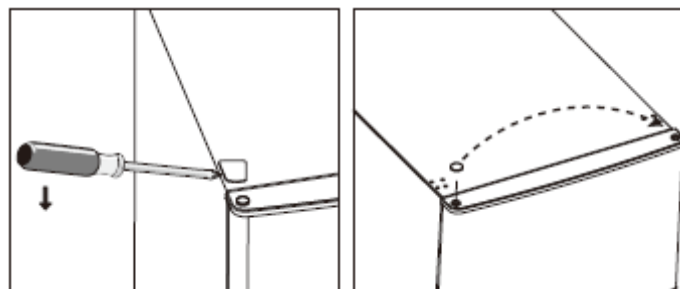

3. Unscrew and remove the bottom hinge pin, turn the bracket over and replace it.

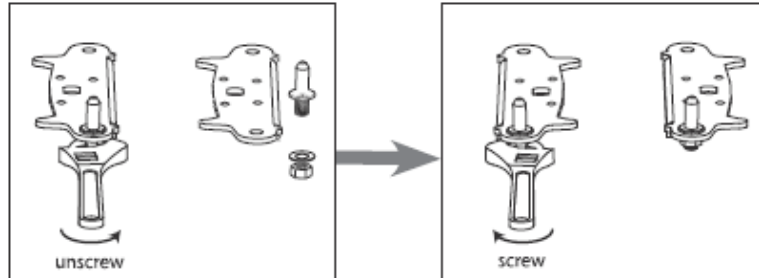

4. Refit the bracket fitting the bottom hinge pin. Replace both adjustable feet.

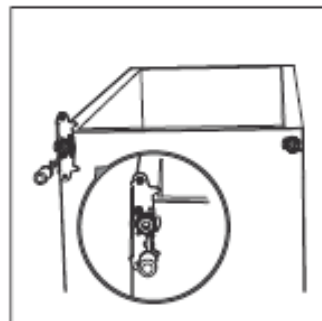

Installation Instructions

5. Place the door back on. Ensure the door is aligned horizontally and vertically so that the seals are closed on all sides before finally tightening the top hinge.

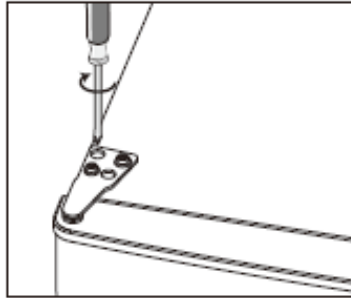

6. Insert the hinge bracket and screw it to the top of the unit.
7. Use a spanner to tighten if necessary.
8. Put the hinge cover and the screw cover back.

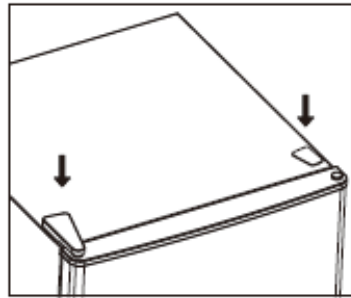

Appliance Details

ELECTRICAL DETAILS

Rated Voltage: 220-240 Vac 50 Hz.
Supply Connection: 10 A domestic socket.
Max Rated Inputs: See data label on unit.

This information can be found on the rating plate (data label) affixed to the rear of the appliance

Dimensions (WxDxH): 545x555x1426mm
Weight: 38Kg

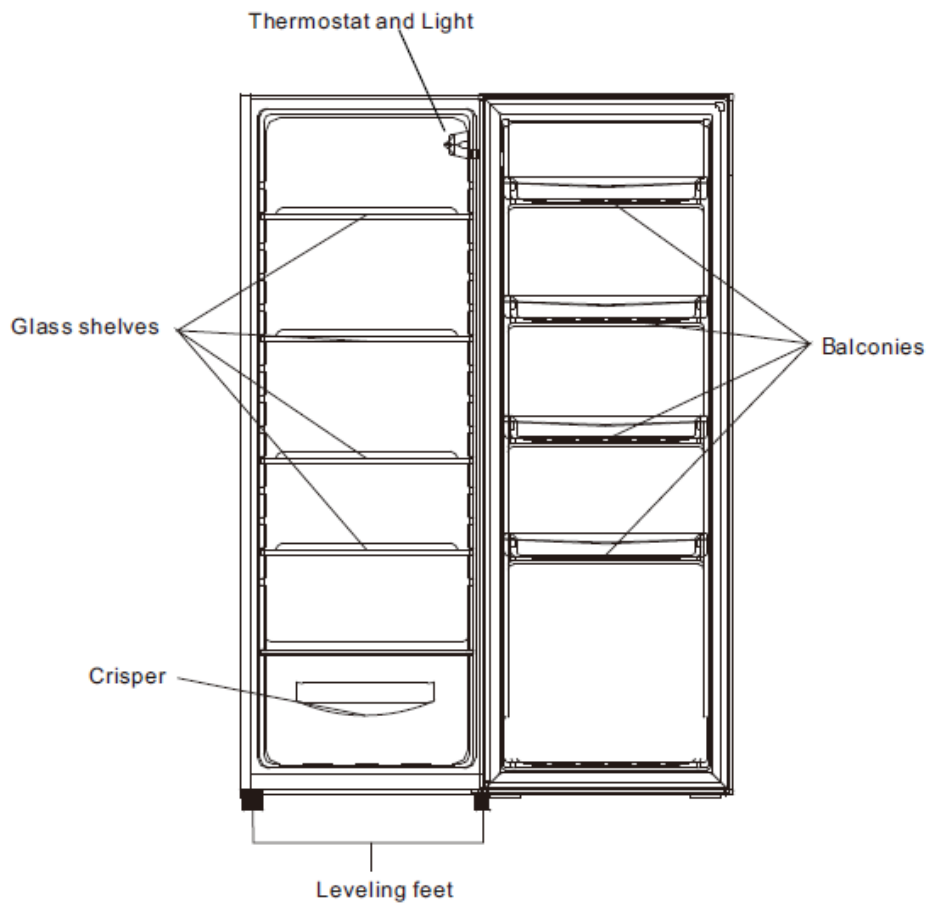

Operating Instructions

FIRST USE

CLEANING THE INTERIOR

Before using the appliance for first time, wash the interior and all internal accessories with lukewarm water and some neutral soap so as to remove the typical smell of a brand-new product, then dry accordingly.

IMPORTANT: Do not use detergent or abrasive powders as these will damage the finish.

TEMPERATURE SETTING

- Plug your appliance. The internal temperature is controlled by a thermostat. There are 8 settings. 1 is warmest setting and 7 is coldest setting. While 0 is to turn off the appliance.
- The appliance may not operate at the correct temperature if it is particularly hot or if you open the door often.

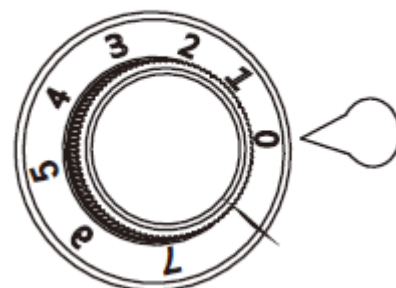

ACCESSORIES

MOVABLE SHELVES

The walls of the refrigerator are equipped with a series of runners so that the shelves can be positioned as desired.

POSITIONING THE DOOR BALCONIES

To permit storage of food packages of various sizes, the door balconies can be placed at different heights. To make these adjustments proceed as follows: gradually pull the balcony in the direction of the arrows until it comes free, then reposition as required.

HELPFUL HINTS AND TIPS

HINTS FOR FRESH FOOD REFRIGERATION

To obtain the best performance:

- Do not store warm food or evaporating liquids in the refrigerator.
- Do cover or wrap the food, particularly if it has a strong flavor.

HINTS FOR REFRIGERATION

- Make (all types): wrap in polythene bags and place on the glass shelves above the vegetable drawer.
- For safety, store in this way only one or two days at the most.
- Cooked foods, cold dishes, etc...: these should be covered and may be placed on any shelf.
- Fruit and vegetables: these should be thoroughly cleaned and placed in the special drawer(s) provided.
- Butter and cheese: these should be placed in special airtight containers or wrapped in aluminum foil or polythene bags to exclude as much air as possible.
- Milk bottle: these should have a cap and should be stored in the balconies on the door.

Care and Maintenance

CLEANING THE APPLIANCE

Upon installation of your new appliance, it is recommended that it be cleaned thoroughly, and cleaned once a month after that.

The appliance may not be connected to mains during cleaning. Danger of electrical shock. Before cleaning the appliance, switch off and unplug the appliance from mains. Never clean the appliance with a steam cleaner. Moisture could accumulate in electrical components and hot vapors can lead to the damage of plastic parts. The appliance must be dry before it is placed back into service.

The outside of the appliance should be cleaned with mild detergent and warm water. Dry the interior and exterior with a soft cloth.

It is recommended that the unit be cleaned each time it is defrosted to help keep the unit odour free and running efficiently.

Do not use oils, abrasive cleaners, petroleum products, acids or alkaline detergents, as they can damage the appliance.

REPLACE THE LAMP

CAUTION: Before replacing the lamp, shall disconnect the appliance from mains power supply.

Lamp specification is listed in rating label.

Follow below process to replace the lamp:

1. Set the temperature regulation knob at number "0" to switch off the appliance.
2. Unplug the appliance to make sure the appliance is disconnected from main power supply.
3. Remove the screw of the lamp cover.
4. Pull the lamp cover out.
5. Unscrew the lamp.
6. Fit new lamp according to the opposite direction, then replace the lamp cover and screw.
7. Plug in the appliance and regulate the knob to right position.

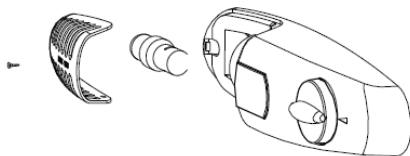

MOVING THE APPLIANCE

Remove all the food.

Securely tape down all loose items inside the appliance. Tape the doors shut.

Be sure the appliance stays in the upright position during transportation.

ENERGY SAVING TIPS

The appliance should be located in the coolest area of the room, away from heat producing appliances or heating ducts, and out of the direct sunlight.

Let hot foods cool to room temperature before placing in the appliance. Overloading the appliance forces the compressor to run longer. Foods that cool or freeze too slowly may lose quality, or spoil.

Be sure to wrap foods properly, and wipe containers dry before placing them in the appliance. This cuts down on frost build-up inside the freezer and bad odors.

The freezer compartment should not be lined with aluminum foil, wax paper, or paper towels. Liners interfere with cold air circulation, making the freezer less efficient.

Organize and label food to reduce door openings and extended searches. Remove as many items as needed at one time and close the door as soon as possible.

When adding fresh food, try to add it to the bottom of the freezer, surrounded by food that is already frozen. After adding fresh food to the freezer, allow 24 hours for it to be fully frozen before adding any more fresh food.

Troubleshooting

PROBLEM	POSSIBLE CAUSE
Appliance does not operate.	Not plugged in. The circuit breaker tripped or a blown fuse.
Temperature inside the appliance is too warm.	Temperature control is set too warm. Turn the control to a cooler setting and allow several hours for the temperature to stabilize. Door is kept open too long or opened too frequently. Open the door less. The door is not closed completely. The door gasket does not seal properly. A large amount of warm or hot food might have been stored recently. Wait until the appliance has had a chance to reach its selected temperature. The appliance has recently been disconnected for a period of time. Four hours are required for the appliance to cool down completely.
Temperature inside the appliance is too cold.	Temperature control is set too cold. Turn the control to a warmer setting and allow several hours for the temperature to stabilize.
Popping or cracking sound when compressor comes on.	Metal parts undergo expansion and contraction, as in hot water pipes. This is normal. Sound will level off or disappear as freezer continues to run.
Bubbling or gurgling sound, like water boiling.	Refrigerant (used to cool appliance) is circulating throughout the system. This is normal.
Vibrations.	Check to assure that the appliance is level. Floor is uneven or weak. Appliance rocks on the floor when it is moved slightly. Be sure floor can adequately support appliance. Level the appliance by adjusting the adjustable feet. The appliance is touching the wall. Re-level the appliance and move it from the wall. See "Installation Instructions".
Moisture forms on outside of appliance.	Door is slightly open, causing cold air from inside the freezer to meet warm moist air from outside.
The door will not close properly.	The appliance is not level. The gasket is dirty.



IMPORTANT: If your appliance appears not to be operating correctly, turn off the appliance at the switch and then contact the Service Department.
DO NOT ATTEMPT TO REPAIR THE APPLIANCE YOURSELF.

The appliance must be accessible for a qualified person to perform any necessary repair.

Robinhood Model No.: RHUFD242W

Upright Refrigerator

Total Volume: 242L

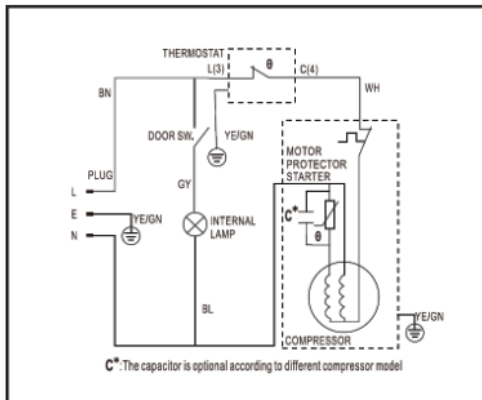

DL1-292A

220 - 240V ~50Hz

Rated Current:

0.55A

Energy Consumption:

130 kWh / year

Climate Class:

T

Refrigerant:

R600a (30g)

Insulation Blow Gas:

Cyclopentane



Caution: Risk of Fire/
Flammable material



Made in China

Warranty Certificate (New Zealand)

Terms and Conditions

The following conditions apply in respect of the warranty given in this certificate:

1. Monaco Corporation Limited ("Monaco") warrants the following Robinhood products against manufacturing defects and faulty materials, under normal use and subject to the exclusions in this certificate, for a period of:
 - Rangehood, Ovens, Cooktops, Dishwashers, Refrigeration - 24 months from date of original purchase for domestic use.
 - Uniduct - 12 months from date of original purchase for domestic use.
 - Ironing centre - 12 months from date of original purchase for domestic use.
 - Sinks sets- 5 years on stainless steel sink including draining bench from date of original purchase for domestic use, 6 months on all stainless-steel accessories, including wire rack, colander and tray from date of original purchase for domestic use.
 - Laundry Tub - 5 years on stainless bowl, 24 months on Tap, Cabinet and other components from the date of original purchase for domestic use.

"Original purchase", when used in this certificate, means purchase by the customer directly from Monaco or one of its approved suppliers.

2. This warranty is limited to the repair or replacement, at our option, within the warranty period of any component part which we at our discretion determine to contain faulty materials or a manufacturing defect in breach of this warranty. This warranty is subject to terms and conditions set out in this certificate.
3. The warranty only applies within New Zealand.
4. The customer must produce the original invoice or other purchase documentation as proof of the original purchase date.

Warranty exclusions

1. The warranty does not apply where, in Monaco's opinion:
 - The defect is caused by misuse, wear and tear, dirt, fire or accidental damage. The product has been repaired or serviced by an unauthorized person.
 - The product was not installed in accordance with our instructions.
 - The product was purchased overseas or was not designed for use in New Zealand. The product was not used, cleaned or cared for in accordance with our instructions.
 - The product was used outdoors.
2. In addition, this warranty does not extend to damage or defects which in our opinion, directly or indirectly arise from or are due to:
 - Exposing the product to acidic or corrosive materials or chemicals such as dyes, solvents, denture cleaner or acetone; Using inappropriate household cleaning products such as abrasive cream or powder cleansers, furniture polish, bleach, mentholated spirits, drain cleaners, sugar soap, metal pads and strongly alkaline or acidic cleaners.
 - Heat damage, including from washing the product at high temperatures.
 - Impact or mishandling the product, including the impact caused by objects scraped along, thrown or dropped on the product surface or excessive weight being placed on the product.
 - Structural or support changes in or affecting the building or the application where the product has been installed.
 - Failure to clean or maintain the product as recommended; or any other causes specified in the product information as being excluded from this warranty.
3. Variations with the color or gloss within the product or any ageing or fading of color, shine or gloss level over time are not covered by this warranty. The warranty does not cover visual imperfections or blemishes in the surface and edges of the product that were not brought to your supplier's attention at the time you inspected the product.
4. Costs incurred on installation or removal of a product, or any reinstallation of a product, or any associated costs, are not covered by this warranty.
5. Monaco will not be liable for consequential or indirect loss or damage whatsoever and however arising out of or in connection with the supply, performance or removal of the product, including (but not limited to) loss of profit, loss of revenue, loss of contract, loss of goodwill or increased cost of workings, even if due to the negligence of Monaco or any of its approved suppliers, employees or agents.
6. Charcoal filters and light bulbs are not covered by this warranty
7. This warranty and the statements contained in this certificate or other documents given to you do not exclude, restrict or modify the application of any term implied into this warranty by statute, provided that (to the extent any statutory provision permits Monaco to limit its liability for a breach of an implied condition or warranty) Monaco's liability for such breach is limited to the payment of the cost of replacing the product, repairing the product or acquiring an equivalent product.
8. Subject to clause 5, our obligations under this warranty are limited to those set out in this certificate, and this warranty is expressly instead of all other warranties, express or implied, including any implied warranty of merchantability or fitness for a particular purpose and notwithstanding any course of dealing between the parties or custom and usage in trade to the contrary.

Terms and conditions are subject to change.

New Zealand

Monaco Corporation Ltd
Telephone: (09) 415 6000
Facsimile: (09) 415 7400
Email: customercare@robinhood.co.nz
www.robinhood.co.nz

Australia

Shiro Australia Pty Ltd
ABN 28 002 386 129
Telephone: 1800 648 556
Facsimile: 1800 628 577
Email: customercare@robinhood.com.au
www.robinhood.com.au