



BUILD YOUR OWN FAIRY HOUSE

CAUTION: Kit contains components with functional sharp points. Adult supervision required. Please dispose of any components if they become damaged after assembly. Use safety goggles at all times. Small parts: not suitable for children under three years.



PART LIST

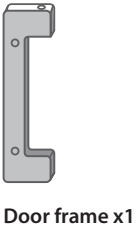

Nails x25
(23 required)

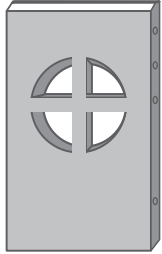

Door frame x1

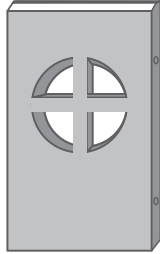

Left window x1



Right window x1

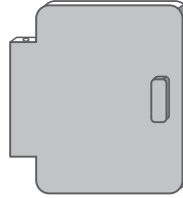

Door x1

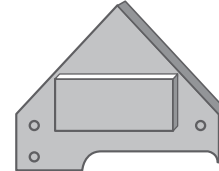

Door beam x1

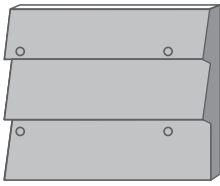

Left eaves x1

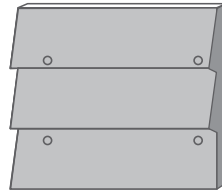

Right eaves x1

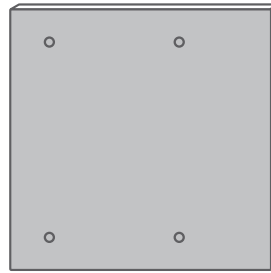

Base x1

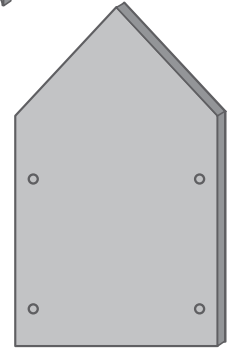

Back panel x1

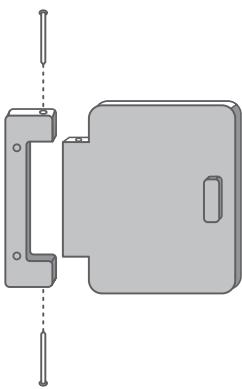

1. Assemble the door to the door frame with 2 nails.

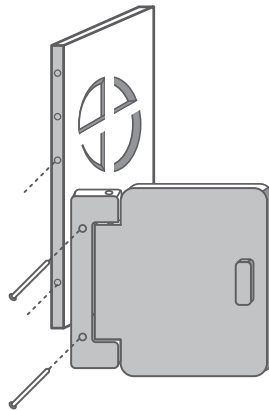

2. Attach the left window to the door frame with 2 nails through the lowest holes.

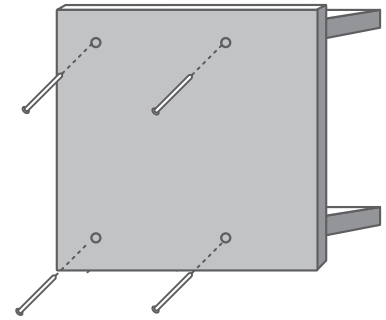

3. Attach the left window to the base using 2 nails through the bottom. Then attach the right window to the base.

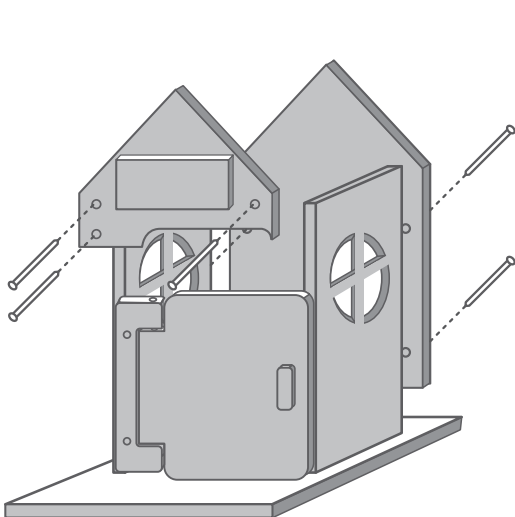

4. Attach the door beam above the door to the sides of the left and right windows. Then attach the back panel to complete the fourth side of the fairy house.

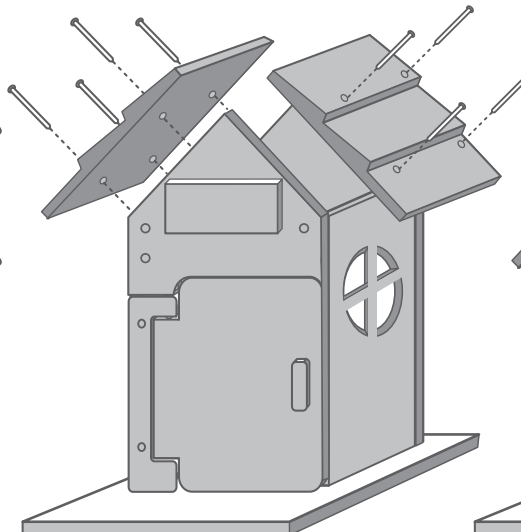

5. Attach the eaves to each side of the roof.

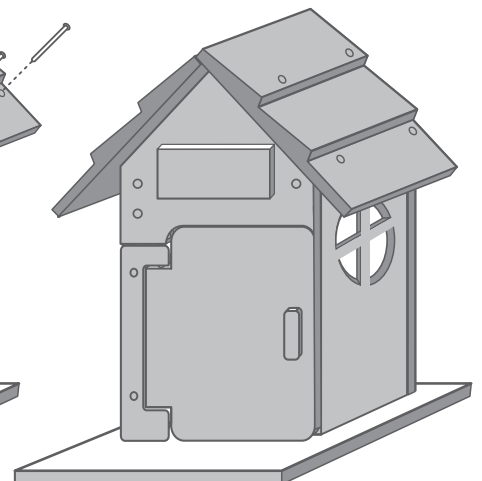

6. FINAL: Decorate with stickers to complete the FAIRY HOUSE.